



PICKFORD

PRECAST CONCRETE



“If it’s precast concrete, then it’s Pickford’s”

Head Office

Design House, Common Bank Industrial Estate
Ackhurst Road, Chorley, Lancashire PR7 1NH

Croston Yard

Twin Lakes Industrial Estate, Brickcroft Lane,
Croston PR26 9RF

PRICE LIST

March 2023 - Digital Copy
Concrete Products

Please refer to our technical specification sheet for further details

Product Code	Description	Length	Width	Depth	Trade Price	Pallet Qty	Weight
PP215x100x140	Padstone	215	100	140	£12.65	60	7.22kg
PP330x100x140	Padstone	330	100	140	£19.08	80	11.10kg
PP440x100x140	Padstone	440	100	140	£25.65	50	14.78kg
PP665x100x140	Padstone	665	100	140	£38.22	12	22.34kg
PP215x100x215	Padstone	215	100	215	£19.18	100	11.09kg
PP330x100x215	Padstone	330	100	215	£29.54	70	17.20kg
PP440x100x215	Padstone	440	100	215	£39.34	50	22.70kg
PP665x100x215	Padstone	665	100	215	£63.67	12	34.31kg
PP890x100x215	Padstone	890	100	215	£85.21	-	45.92kg
PP330x100x290	Padstone	330	100	290	£39.80	44	22.97kg
PP440x100x290	Padstone	440	100	290	£53.03	32	30.62kg
PP665x100x290	Padstone	665	100	290	£85.83	12	46.28kg
PP890x100x290	Padstone	890	100	290	£126.34	4	61.94kg
PP215x140x140	Padstone	215	140	140	£15.65	45	10.11kg
PP330x140x140	Padstone	330	140	140	£21.80	60	14.11kg
PP440x140x140	Padstone	440	140	140	£31.99	48	20.70kg
PP665x140x140	Padstone	665	140	140	£53.17	12	31.28kg
PP215x140x215	Padstone	215	140	215	£26.89	75	15.53kg
PP330x140x215	Padstone	330	140	215	£44.13	33	23.84kg
PP440x140x215	Padstone	440	140	215	£55.14	40	31.79kg
PP665x140x215	Padstone	665	140	215	£89.22	12	48.04kg
PP890x140x215	Padstone	890	140	215	£119.38	-	64.29kg
PP330x140x290	Padstone	330	140	290	£54.43	27	32.16kg
PP440x140x290	Padstone	440	140	290	£74.23	24	42.87kg
PP665x140x290	Padstone	665	140	290	£120.10	12	64.80kg
PP215x215x215	Padstone	215	215	215	£41.34	40	23.85kg
PP330x215x215	Padstone	330	215	215	£67.85	22	36.61kg
PP440x215x215	Padstone	440	215	215	£84.54	20	48.81kg
PP665x215x215	Padstone	665	215	215	£138.93	12	73.78kg
PP890x215x215	Padstone	890	215	215	£204.52	4	98.74kg

Please refer to our technical specification sheet for further details

Product Code	Description	Length	Width	Depth	Trade Price	Pallet Qty	Weight
PP330x215x290	Padstone	330	215	290	£85.38	18	49.38kg
PP440x215x290	Padstone	440	215	290	£113.90	16	65.84kg
PP665x215x290	Padstone	665	215	290	£172.22	12	99.51kg
PP330x330x215	Padstone	330	330	215	£106.97	N/A	56.19kg
PP330x330x140	Padstone	330	330	140	£63.60	N/A	36.59kg
PP440x440x140	Padstone	440	440	140	£123.85	N/A	65.05kg
PP440x330x215	Padstone	440	330	215	£151.20	N/A	74.48kg
PP440x440x215	Padstone	440	440	215	£190.20	N/A	99.90kg

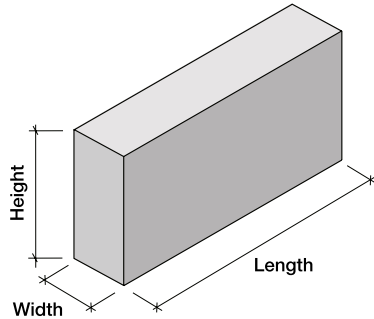
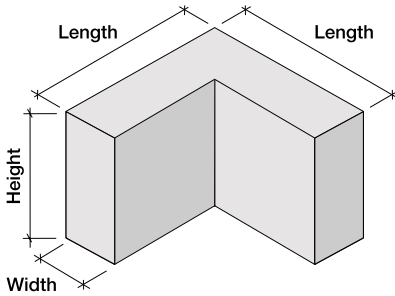

Product Code	Description	Length	Width	Depth	Trade Price	Pallet Qty	Weight
PP215/215x100x140	L-Shaped Padstone	215/215	100	140	£71.91	N/A	14.40kg
PP215/215x140x140	L-Shaped Padstone	215/215	140	140	£82.97	N/A	15.60kg
PP215/215x100x215	L-Shaped Padstone	215/215	100	215	£56.03	N/A	16.80kg
PP215/215x140x215	L-Shaped Padstone	215/215	140	215	£104.77	N/A	31.20kg
PP330/330x100x140	L-Shaped Padstone	330/330	100	140	£74.78	N/A	18.72kg
PP330/330x140x140	L-Shaped Padstone	330/330	140	140	£104.73	N/A	26.40kg
PP330/330x100x215	L-Shaped Padstone	330/330	100	215	£124.52	N/A	40.25kg
PP330/330x140x215	L-Shaped Padstone	330/330	140	215	£160.51	N/A	57.12kg
PP440/440x100x140	L-Shaped Padstone	440/440	100	140	£110.49	N/A	23.52kg
PP440/440x140x140	L-Shaped Padstone	440/440	140	140	£130.55	N/A	36.48kg
PP440/440x100x215	L-Shaped Padstone	440/440	100	215	£161.72	N/A	40.25kg
PP440/440x140x215	L-Shaped Padstone	440/440	140	215	£228.77	N/A	56.16kg
PP440/440x100x290	L-Shaped Padstone	440/440	100	290	£236.19	N/A	62.40kg
PP660/660x100x215	L-Shaped Padstone	660/660	100	215	£242.58	N/A	68.62kg

Please refer to our technical specification sheet for further details

Unit	Length	Width	Height	Stock Price	Weight	Pallet Qty
ChamferedThreshold Type 1*	996	150	140	£63.64	50.20kg	24
Chamfered Threshold Type 1	1002	150	140	£64.07	50.50kg	24
Chamfered Threshold Type 1	1240	150	140	£79.88	63.00kg	24
Chamfered Threshold Type 1	1580	150	140	£104.54	80.64kg	18
Chamfered Threshold Type 2	1640	150	140	£106.93	83.70kg	32
Chamfered Threshold Type 2	1002	100	140	£42.70	33.67kg	32
Chamfered Threshold Type 2	1250	100	140	£53.26	42.00kg	32
Chamfered Threshold Type 2	1340	100	140	£57.09	45.02kg	24
Chamfered Threshold Type 2	1565	100	140	£66.90	52.58kg	32
Chamfered Threshold Type 2	1800	100	140	£76.70	60.48kg	24
Chamfered Threshold Type 3	1002	100	65	£19.83	15.63kg	24
Chamfered Threshold Type 4*	1002	215	75	£49.17	38.78kg	N/A
Bullnosed Threshold Type 5	890	100	140	£38.01	29.90kg	32
Bullnosed Threshold Type 5	1002	100	140	£42.70	33.67kg	32
Bullnosed Threshold Type 5	1115	100	140	£47.52	37.46kg	32
Bullnosed Threshold Type 5	1250	100	140	£53.26	42.00kg	32
Bullnosed Threshold Type 5	1340	100	140	£57.09	45.02kg	24
Bullnosed Threshold Type 5	1452	100	140	£65.33	48.79kg	24
Bullnosed Threshold Type 5	1565	100	140	£66.67	52.58kg	24
Bullnosed Threshold Type 5	1678	100	140	£71.51	56.38kg	24
Bullnosed Threshold Type 5	1800	100	140	£76.70	60.48kg	24
Bullnosed Chamfered Threshold Type 6*	1002	200	140	£85.42	67.33kg	N/A

* Non stock item available to order

We stock over 40 different profiles of thresholds available to order.

Please contact our sales office for further details.

Please refer to our technical specification sheet for further details

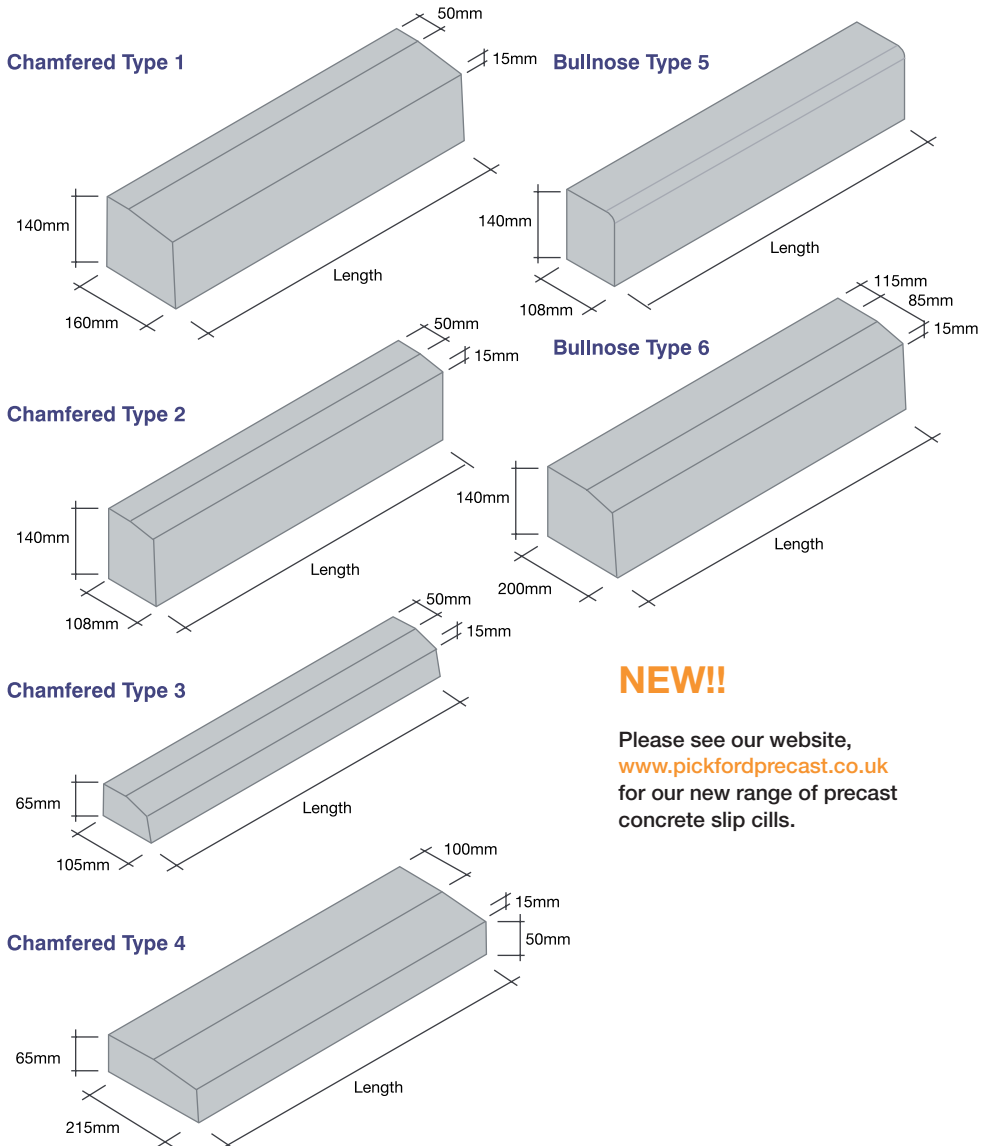

NEW!!

Please see our website,
www.pickfordprecast.co.uk
for our new range of precast
concrete slip cills.

Please note - size shown on illustrations include demoulding taper.

Please refer to our technical specification sheet for further details

Twice Weathered and Throated - Grey - * Not Throated (NO Drip)

Product Code	Unit	Length	Width	Depth	Stock Status	Trade Price	Weight	Pallet Qty
COP15	Straight	610	140	50/30	Stock	£8.90	8.20kg	100
COP14*	Straight	610	280	50/30	Stock	£15.92	16.40kg	40
COP4	Straight	610	305	75/50	Stock	£27.12	27.91kg	30
COP32	Straight	915	315	100/80	Stock	£65.82	62.26kg	15
COP6A	Straight	915	355	75/50	Stock	£49.65	48.72kg	15
COP5	Straight	915	405	75/50	Stock	£56.67	55.59kg	15
COP8	Straight	915	460	75/50	Stock	£65.62	63.14kg	10
COP10	Straight	915	510	75/50	Stock	£82.92	70.00kg	10
COP11	Straight	915	610	75/50	Stock	£113.54	83.72kg	10

Once Weathered and Throated - Grey - * Not Throated (NO Drip)

Product Code	Unit	Length	Width	Depth	Stock Status	Trade Price	Pallet Qty	Weight Kgs
COP20	Straight	610	165	60/50	Stock	£8.90	13.29kg	60
COP21*	Straight	610	222	70/50	Stock	£18.55	19.50kg	40
COP52	Straight	900	280	50/40	Stock	£28.94	27.22kg	30
COP22	Straight	610	305	70/50	Stock	£27.12	6.79kg	30
COP29	Straight	1000	315	100/75	Stock	£50.73	66.15kg	15
COP23A	Straight	915	355	75/50	Stock	£50.38	48.72kg	15
COP24	Straight	900	405	75/50	Stock	£56.67	54.68kg	15
COP25	Straight	915	460	75/50	Stock	£65.63	63.14kg	10
COP26	Straight	915	510	75/50	Stock	£82.92	70.00kg	10
COP27	Straight	915	610	75/50	Stock	£113.54	83.72kg	10

Flat and Throated - Grey

Product Code	Unit	Length	Width	Depth	Stock Status	Trade Price	Pallet Qty	Weight Kgs
COP30	Straight	900	300	60	Stock	£29.77	38.88kg	30
COP57	Straight	610	355	50	Stock	£39.30	25.99kg	15
COP31	Straight	900	400	60	Stock	£58.21	51.84kg	15

Flat Chamfered and Throated - Grey

Product Code	Unit	Length	Width	Depth	Stock Status	Trade Price	Pallet Qty	Weight Kgs
COP44	Straight	900	325	100	Stock	£81.03	70.20kg	30

Coloured Copings

Twice and Once Weathered Copings available in the following colours:

Buff - Off White - Blue/Black

Trade Price

P.O.A.

Please refer to our technical specification sheet for further details

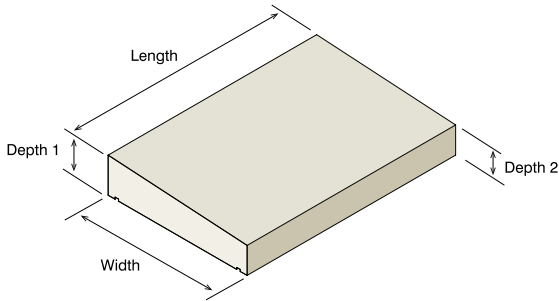

Once Weathered

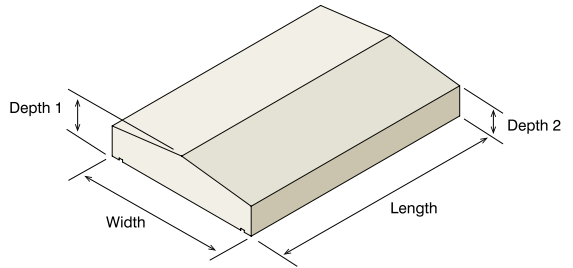

Twice Weathered

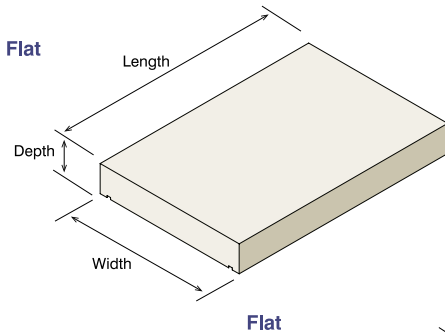

Flat

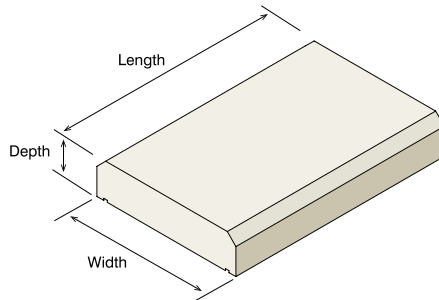

Twice Chamfered

Ex-Stock available for delivery 5-7 working days, Next day delivery available for a surcharge*

Available in full and part pack*

Discounts available for volume

We stock lengths and sections as shown in the table opposite

We can produce bespoke lengths and sections to order, also colours available no problem!

All deliveries are carriage paid in order consignments of £500.00

Please see our website, www.pickfordprecast.co.uk for our full range of Concrete Copings

* Subject to stock availability

Please refer to our technical specification sheet for further details

Four Times Weathered and Throated - Grey

Product Code	Unit	Width 1	Width 2	Height	Stock Status	Trade Price	Weight
CAP001	Pier	Cap	305	305	75/50	£12.60	13.29kg
CAP006	Pier	Cap	380	380	95/50	£20.43	23.00kg
CAP016	Pier	Cap	420	420	95/45	£24.78	26.65kg
CAP018	Pier	Cap	530	530	95/50	£43.38	44.73kg
CAP022	Pier	Cap	650	650	100/80	£94.32	89.71kg

Four Times Weathered and Throated - Coloured*

Product Code	Unit	Width 1	Width 2	Height	Stock Status	Trade Price	Weight
CAP001/*	Pier Cap	305	305	75/50	Stock	£16.57	13.29kg
CAP006/*	Pier Cap	380	380	95/50	Stock	£30.76	23.00kg
CAP016/*	Pier Cap	420	420	95/45	Stock	£43.36	26.65kg
CAP018/*	Pier Cap	530	530	95/50	Stock	£62.31	44.73kg
CAP022/*	Pier Cap	650	650	100/80	Stock	£138.06	89.71kg

Four Times Weathered and Throated - NON Stock Sizes

Product Code	Unit	Width 1	Width 2	Height	Stock Status	Trade Price	Weight
CAP013/*	Pier Cap	405	405	80/45	Non Stock	P.O.A.	22.77kg
CAP004/*	Pier Cap	455	455	85/50	Non Stock P	P.O.A.	31.28kg
CAP012/*	Pier Cap	455	300	95/45	Non Stock	P.O.A.	20.62kg
CAP005/*	Pier Cap	500	400	95/45	Non Stock	P.O.A.	30.22kg
CAP007/*	Pier Cap	500	500	95/45	Non Stock	P.O.A.	37.77kg
CAP008/*	Pier Cap	500	390	95/45	Non Stock	P.O.A.	29.46kg
CAP024/*	Pier Cap	530	530	200/50	Non Stock	P.O.A.	68.82kg
CAP011/*	Pier Cap	550	550	125/50	Non Stock	P.O.A.	55.58kg
CAP009/*	Pier Cap	550	550	110/50	Non Stock	P.O.A.	51.88kg
CAP021/*	Pier Cap	550	550	100/80	Non Stock	P.O.A.	69.17kg
CAP020/*	Pier Cap	550	440	95/50	Non Stock	P.O.A.	38.54kg
CAP010/*	Pier Cap	600	600	110/50	Non Stock	P.O.A.	61.74kg
CAP003/*	Pier Cap	635	635	90/45	Non Stock	P.O.A.	59.27kg
CAP019/*	Pier Cap	800	450	75/50	Non Stock	P.O.A.	51.45kg

*Colours: Buff - Off White - Blue/Black

Pier Caps

www.padstonesfromstock.co.uk

Please refer to our technical specification sheet for further details

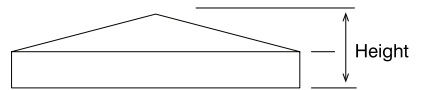
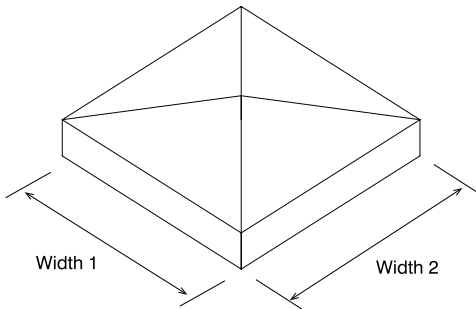
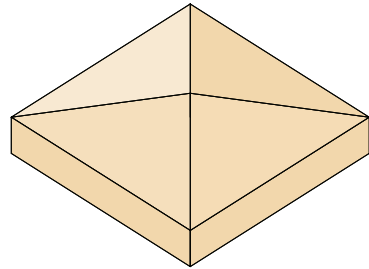
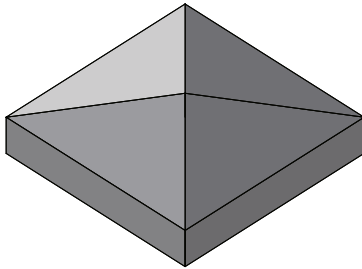
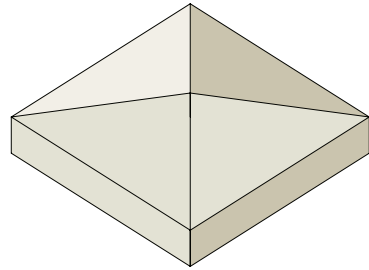
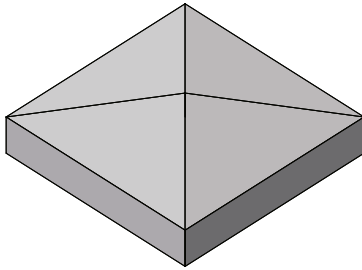

The colours shown are as a guide only - please ask for colour sample

Ex-Stock available for delivery 5-7 working days, Next day delivery available for a surcharge*

Available in full and part pack*

Discounts available for volume

We stock lengths and sections as shown in the table opposite

We can produce bespoke lengths and sections to order, also colours available no problem!















All deliveries are carriage paid in order consignments of £500.00

Please see our website, www.pickfordprecast.co.uk for our full range of Concrete Copings

* Subject to stock availability

Call: 01257 441514 Fax: 01257 266846 Email: sales@pickfordprecast.co.uk All prices subject to VAT

Prestressed Lintels

	HIGH STRENGTH		FAIR FACED		FAIR FACED & FIRE SPEC	
	Reference	Price £/m	Reference	Price £/m	Reference	Price £/m
100mm Wide Sections						
	T0	P.O.A.	T0FF	P.O.A.	T0FFFR	P.O.A.
	T1	P.O.A.	T1FF	P.O.A.	T1FFFR	P.O.A.
	T2	P.O.A.	T2FF	P.O.A.	T2FFFR	P.O.A.
	T3	P.O.A.	T3FF	P.O.A.	T3FFFR	P.O.A.
	Reference	Price £/m	Reference	Price £/m	Reference	Price£/m
140mm Wide Sections						
	T1R	P.O.A.	T1RFF	P.O.A.	T1RFFFR	P.O.A.
	T4	P.O.A.	T4FF	P.O.A.	T4FFFR	P.O.A.
	T5	P.O.A.	T5FF	P.O.A.	T5FFFR	P.O.A.
	T6	P.O.A.	T6FF	P.O.A.	T6FFFR	P.O.A.
	Reference	Price £/m	Reference	Price £/m	Reference	Price£/m
190mm Wide Sections						
	T7	P.O.A.	T7FF	P.O.A.	T7FFFR	P.O.A.
	T8	P.O.A.	T8FF	P.O.A.	T8FFFR	P.O.A.
	T9	P.O.A.	T9FF	P.O.A.	T9FFFR	P.O.A.
	Reference	Price £/m	Reference	Price £/m	Reference	Price£/m
215mm Wide Sections						
	T5R	P.O.A.	T5RFF	P.O.A.	T5RFFFR	P.O.A.
	T10	P.O.A.	T10FF	P.O.A.	T10FFFR	P.O.A.
	T11	P.O.A.	T11FF	P.O.A.	T11FFFR	P.O.A.

Concrete Bollards

Concrete Lintels

High Strength Dense Concrete

Pickford BOL 2 is a free standing bollard with holes cast in for chain attachment.



Trade Price
£109.45

Pickford BOL 3/5 bollards is installed buried at least 300mm below finished level. Installed depth should be increased to allow for surface finishes.



Trade Price
£120.40

Dimensions and weights

BOL 2		BOL 3	
Height:	510mm	Height:	1070mm
Base:	300mm	Base:	225mm
Top:	250mm	Top:	150mm
Weight:	70kg	Weight:	66kg
No/pallet:	8	No/pallet:	10

BOL 5	
Height:	1370mm
Base:	225mm
Top:	150mm
Weight:	95kg
No/pallet:	10

Standard Range (Fully Reversible)

100mm Wide Sections

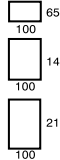

Type	Price	£ per m
P100		P.O.A.
R15		P.O.A.
R22		P.O.A.

140mm Wide Sections

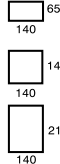

Type	Price	£ per m
P150		P.O.A.
S15		P.O.A.
R21		P.O.A.

215mm Wide Sections



Type	Price	£ per m
P220		P.O.A.



Product Range:

- Padstones
- Concrete Copings
- Thresholds
- Cast Stone
 - Wet Cast
 - Semi Dry
- Bespoke Concrete Products
- Concrete Stairs
- Concrete Bollards
- High Strength Concrete Lintels
- Steel Lintels

• *Contact our sales department with all your requirements on:*

Tel: 01257 441514

Fax: 01257 266846

Pickford Precast

Unique Selling Point

Features and Benefits:

- We can offer national distribution.
- Quality and consistency guaranteed.
- Technical back up and expertise.
- Can be delivered in conjunction with other products.
- Simple pricing policy.
- One source of supply for all ranges.
- Rapid response to deliveries.
- Comprehensive stocks carried.

Extra Charges:

- Timed deliveries.
- London congestion charge.
- Rigid vehicles.
- Moffatt/Self off load.
- Waiting time.

Carriage Charges:

Pickford Precast Concrete reserve the right to charge carriage dependant on load size and distance to site.

General Conditions of Sale

- (1) All quotations, tenders and price lists are subject to withdrawal without notice, and any acceptance of any quotation, tender or price list will not effect a binding contract, unless and until confirmed by us.
- (2) Notwithstanding any offer, quotation, tender or price list, orders are accepted only subject to the conditions that the goods will be invoiced at the prices ruling at the date of their despatch.
- (3) In the event of an Account not being paid punctually, we reserve the right to cancel any Contract, order or balance or portion of an order and any claims which we may have at law shall not be prejudiced thereby.
- (4) Offers to deliver goods are for delivery to a good hard and reasonably accessible road nearest to the site where the goods are to be employed or stored.
- (5) On the due arrival of our delivery vehicle it is the responsibility of the customer to unload the goods promptly. The customer shall be responsible for any damage during unloading and for all costs occasioned by his undue delay in commencing or carrying out this work or by his failure to unload. When products are unloaded by our crane hoist, supplementary conditions of sale which govern unloading appliances override these general conditions only to the extent to which the two are inconsistent. While every effort will be made to meet collection or delivery arrangements, no liability will be accepted with regard to delay in supplying goods or in starting or carrying out work.
- (6) We will accept no claim that goods, materials or work are unsuitable other than on the grounds of alleged defective workmanship or material. In any such case notification must be made in writing, within three days of delivery of such goods or material or the execution of such work and in any event the allowance shall not exceed the price charged for such goods, materials or work and will be limited to the direct cost of replacing or rectifying such goods, materials or work.
- (7) Once the Customer has accepted goods, materials or work supplied by us, whether by signing a delivery note or using such goods or materials or by approving such work or in any other way, he will be stopped from claiming that such goods, materials or work were unsuitable at the time of acceptance unless prior to or at the time of such acceptance he gave written notice specifying the unsuitable nature of such goods, materials or work.
- (8) The sizes and weights shown on price lists or quotations are approximate only, as variations in manufacture and materials cannot be avoided.
- (9) We will entertain no claim for breakage, damage or shortage in respect of goods sent carriage paid unless the following conditions are complied with: If delivered by road by us: Breakages must be brought to the notice of the driver and noted on his receipt for delivery. Notification, in writing, must also be given to us immediately, and received by us within three days of the delivery of the goods. If delivered by the customer's lorry: No breakage claim will be recognised, as our liability ceases immediately the goods are loaded into the customer's lorry at works or depot.
- (10) No claim will be allowed in respect of goods, products and materials supplied by us after such goods, products or materials have been laid, erected or otherwise used by the customer or another or others beyond our control in a manner contrary to our recommendations of good practice.
- (11) No liability will be accepted in respect of any error or omission in any layout drawing, plan, schedule or recommendation which we may submit to the use of any goods, products or materials which we supply.
- (12) The customer shall indemnify us in respect of all costs which we incur through no fault of our own as a result of any change in the requirements after acceptance of order.

For full Pickford Terms and Conditions please contact us.



Design House, Common Bank Industrial Estate
Ackhurst Road, Chorley, Lancashire PR7 1NH

Call: 01257 441514 Fax: 01257 266846

Email: sales@pickfordprecast.co.uk

www.pickfordprecast.co.uk

www.padstonesfromstock.co.uk